



V **E** **X**®

ROBOTICS

COMPETITION

SKYRISE



Table of Contents

Section 1 – Introduction	1
Section 2 – The Game	3
Section 3 – The Tournament	15
Section 4 – The Robot	20





SECTION

Introduction

Overview

This section provides an introduction to *VEX Skyrise* and the VEX Robotics Competition.

The VEX Robotics Competition

The world needs the students of today to become the scientists, engineers, and problem solving leaders of tomorrow. The constant breakthroughs in chemistry, medicine, materials and physics reveal a new set of challenges and create an even greater opportunity for problem solving through technology. These problems are not academic; the solutions could help save the world and those technology problem solvers will be the ones to make it possible.

This underscores the dramatic challenge we face: there are not enough high school graduates choosing technology related disciplines in college. This does not reflect a lack of capacity for new students on the part of technical schools and universities, but a lack of interested and qualified applicants. In short, we will not have the people we require in the next generation to solve the problems of tomorrow unless the shortage is directly addressed today. Who will solve the world's next great crisis?

Recognizing this dilemma, scores of organizations are creating programs designed to attract and engage young students in the study of science and technology. Many have found that robotics is a very powerful platform to attract and hold the attention of today's multi-tasking, connected youths. Robotics has strong appeal to this intensely competitive generation and represents the perfect storm of applied physics, mathematics, computer programming, digital prototyping and design, integrated problem solving, teamwork and thought leadership. Students with a previously undiscovered aptitude for STEM (Science, Technology, Engineering, and Math) curriculum are flourishing in growing numbers due to the efforts of schools, volunteer organizations, corporations, and governments internationally.

The VEX Robotics Competition, operated by the Robotics Education and Competition Foundation, is a program that inspires thousands of students worldwide to pursue STEM-related education and career paths. While there are many quality robotics competitions worldwide, the VEX Robotics user community has overwhelmingly demanded *new* challenges that are easy and economical to host and implement.

The VEX Robotics Design System helps takes the inspiration from the competition to the next level. The system is used as a classroom robotics platform designed to nurture creative advancement in robotics and knowledge of STEM education. VEX provides teachers and students with an affordable, robust, and state-of-the-art robotics system suitable for classroom use and the playing field. VEX's innovative use of pre-manufactured and easily formed structural metal, intuitive mechanical parts combined with a powerful range of user-programmable microprocessors for control, leads to infinite design possibilities.

For more information on VEX visit www.vexrobotics.com. Follow us on Twitter @VEXRobotics. Like us on Facebook at www.facebook.com/vexrobotics

For more information on the Robotics Education and Competition Foundation visit www.roboticseducation.org. Follow us on Twitter @REC_Foundation. Like us on Facebook at www.facebook.com/RECFoundation

Visit RobotEvents.com for more information on the VEX Robotics Competition, including team registration, event listings and results and more.

VEX *Skyrise* – A Primer

VEX *Skyrise* is played on a 12 ft x 12 ft foam-mat, surrounded by a sheet-metal and lexan perimeter. There are forty four Cubes and fourteen *Skyrise* Sections, which teams can Score and Build in a variety of ways.

For more details and specific game-play rules, please see Section 2 – The Game.

While participating in the VRC *Skyrise* season, teams will develop many new skills in response to the challenges and obstacles that stand before them. Some problems will be solved by individuals, while others will be handled through interaction with their student teammates and adult mentors. Teams will work together to build a VEX robot to compete in one of many tournaments, where they celebrate their accomplishments with other teams, family and friends. After the season, students come away not only with the accomplishment of building their own competition robot, but with an appreciation of science and technology and how they might use it to positively impact the world around them. In addition, they cultivate life skills such as planning, brainstorming, collaboration, teamwork, and leadership as well as research and technical skills.

2

SECTION

The Game

Overview

This section describes the VEX Robotics Competition game, called *VEX Skyrise*. It also lists the game definitions and game rules.

Game Description

Matches are played on a field set up as illustrated in the figures below. Two *Alliances* – one “red” and one “blue” – composed of two teams each, compete in each *Match*. The object of the game is to attain a higher score than the opposing *Alliance* by *Scoring* your colored *Cubes in Floor Goals*, on *Posts* or on your *Skyrise*, by *Owning Posts*, and by *Building* your *Skyrise Sections*.

A bonus is awarded to the *Alliance* that has the most total points at the end of the *Autonomous Period*.

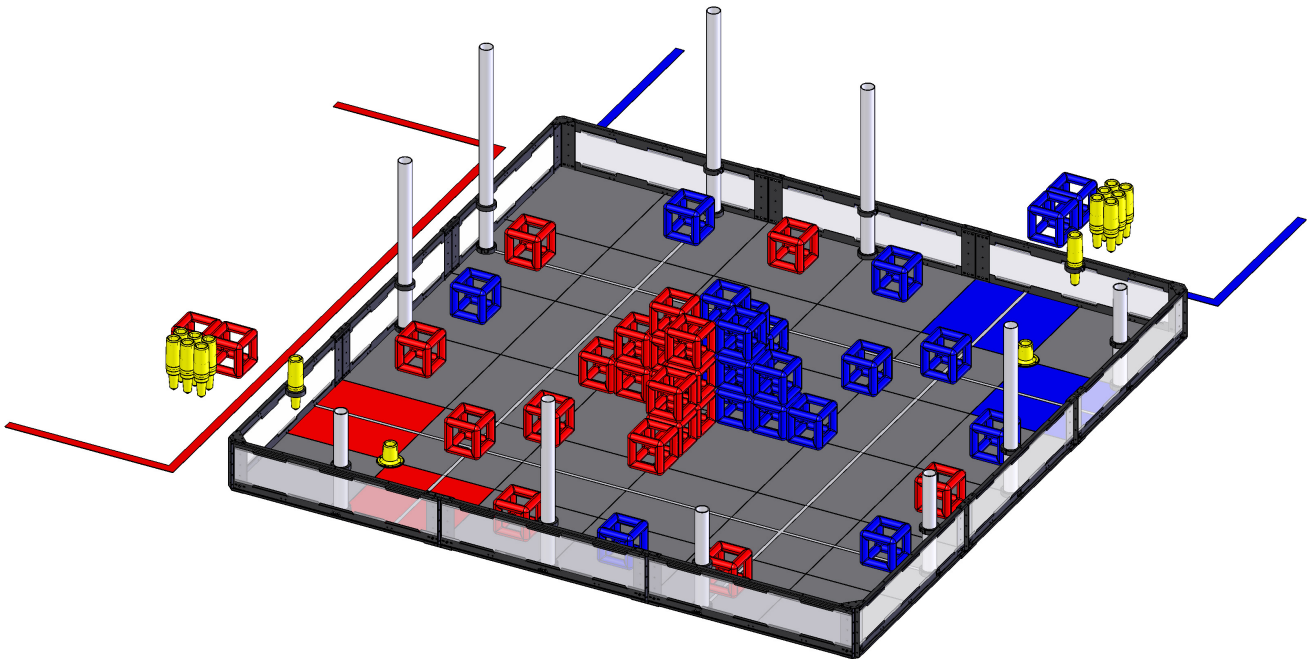
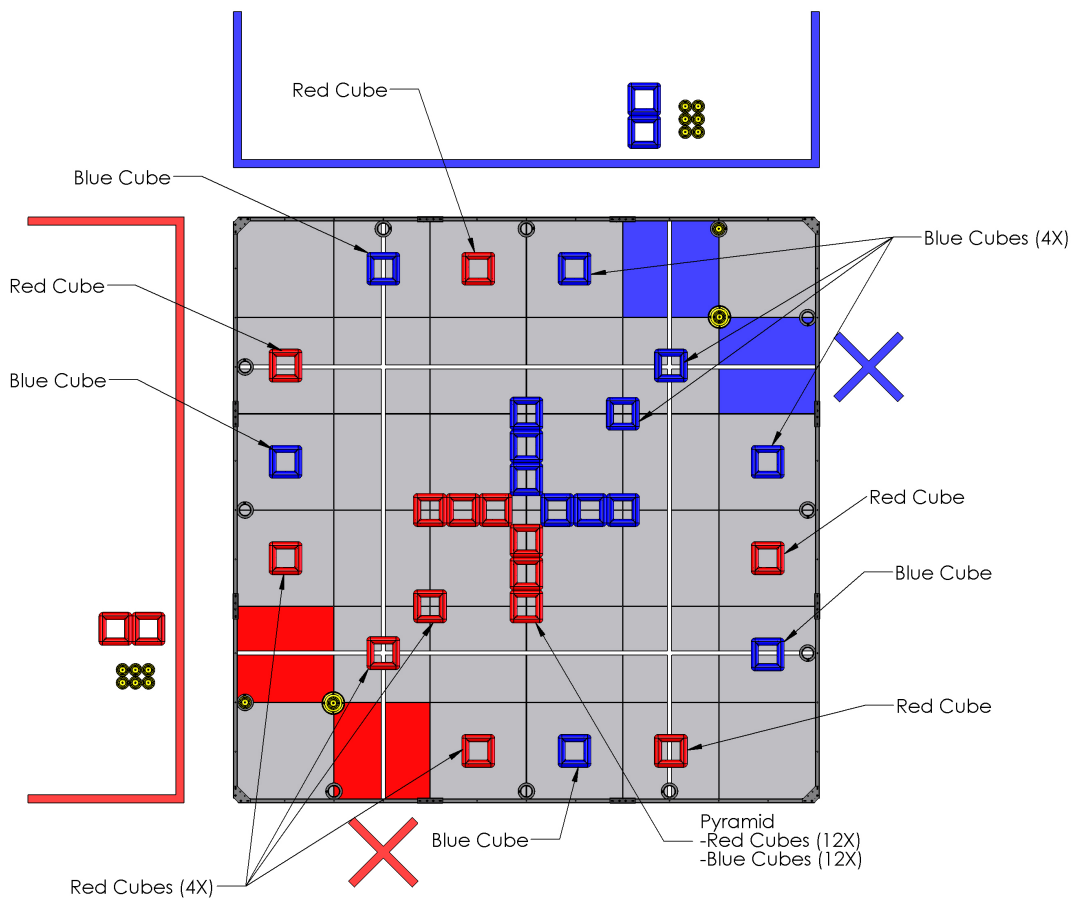
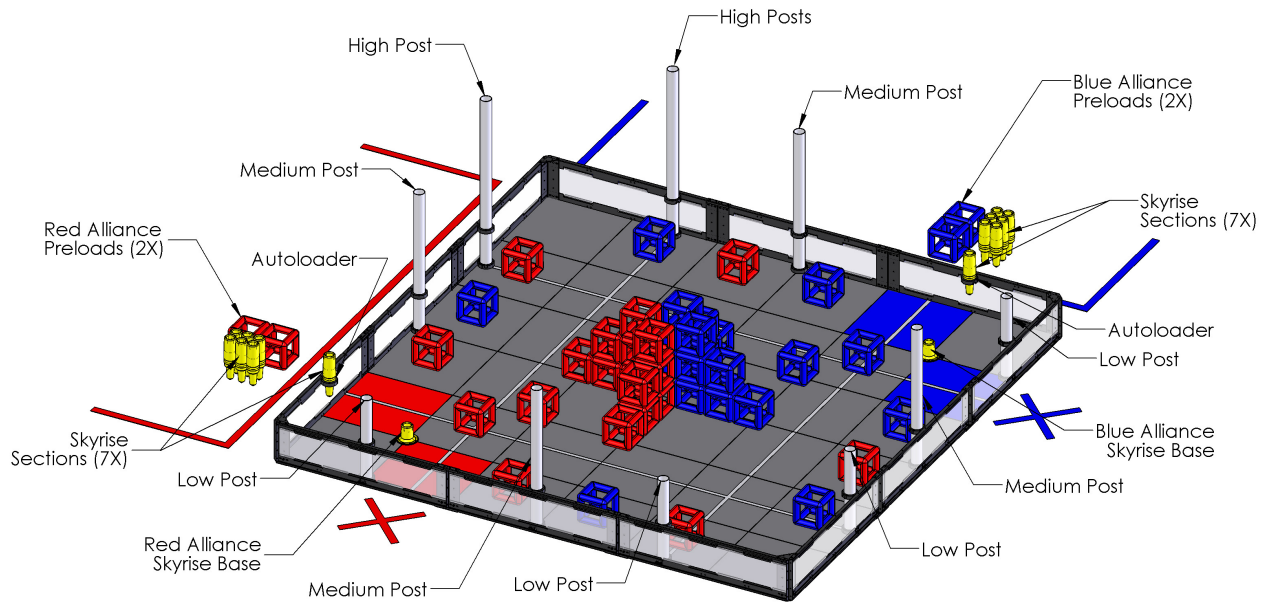

Figure 1: Isometric view of the field

Note: The illustrations in this section of the manual are only provided to give a general visual understanding of the game. Teams should refer to the official field specs available in Appendix A for exact field dimensions, a full field BOM, exact details of field construction, and lower cost field options.

There are a total of forty-four (44) *Cubes*, twenty-two (22) red and twenty-two (22) blue, and fourteen (14) *Skyrise Sections* in a *VEX Skyrise Match*. Each *Robot* will have one (1) *Cube* available as a *Preload* and seven (7) *Skyrise Sections* available to be placed in its *Alliance’s Autoloader* during the *Match*. Forty (40) *Cubes* will start at designated locations on the field. There are ten (10) *Posts* of varying height around the field and each *Alliance* has one (1) *Skyrise Base*.

VEX Robotics Competition - *Skylrise*



Figures 2 & 3: Annotated views of the field

VEX Robotics Competition - *Skyrise*

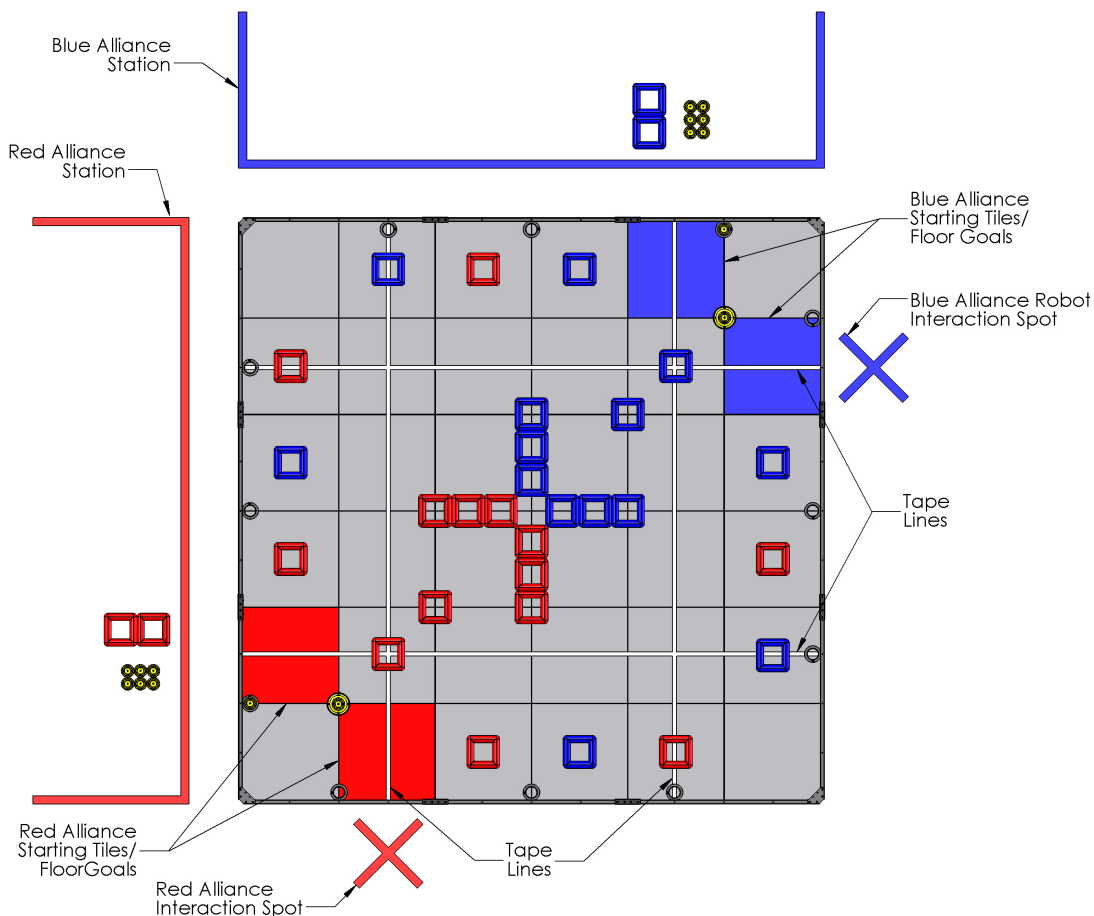

Figure 4: Annotated overhead view of the field

Game Definitions

Adult – Anyone not meeting the definition of *Student*.

Alliance – A pre-assigned grouping of two teams that work together for a given *Match*.

Alliance Robot Interaction Spots – The colored (red or blue) X's from which a *Student Drive Team Member* may interact with the *Robot* as per <SG4>.

Alliance Starting Tile – A colored tile (red or blue), that designates the location where *Robots* must start the match.

Alliance Station – The designated region where the *Drive Team Members* must remain during their *Match*.

Autoloader – The designated holding spot where *Student Drive Team Members* may place *Skyrise Sections* during a *Match*.

Autonomous Period – A 15-second (0:15) time period when the *Robots* operate and react only to sensor inputs and to commands pre-programmed by the team into the onboard *Robot* control system.

VEX Robotics Competition - *Skyrise*

Built – A *Skyrise Section* is **Built** if it is not touching a *Robot* of the same color as the *Alliance Starting Tile* the *Skyrise Base* is adjacent to and either:

- a) Fully nested within the *Skyrise Base* (see Figures 5 & 6)
- b) Fully nested within a *Skyrise* (see Figures 7 & 8)



Figure 5 – A Built Skyrise, with a Skyrise Section fully nested within a Skyrise Base

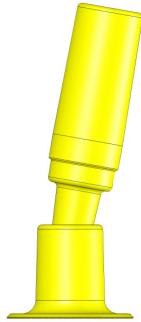

Figure 6 – A Non Built Skyrise, with a Skyrise Section not fully nested within a Skyrise Base



Figure 7 – A Built Skyrise (two built Skyrise Sections), with a Skyrise Section fully nested within a Skyrise

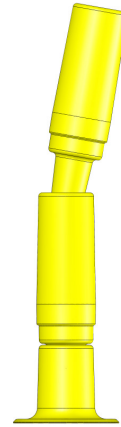

Figure 8 – A Built Skyrise (one built Skyrise Sections), with a Skyrise Section not fully nested within a Skyrise

Carry – The act of a robot intentionally controlling the motion and or position of a *Skyrise Section*

Cube – A red or blue plastic cube shaped *Scoring Object* with an overall length of 8", consisting of tubular segments of approximately 1.75" in diameter.

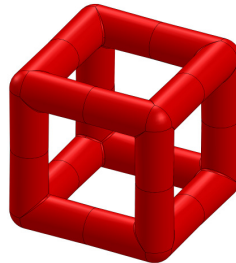

Figure 9 – A red Cube

Disablement – A penalty applied to a team for a rules violation. A team that is *Disabled* in a *Match*, is no longer allowed to operate its robot, and will be asked to place its controller on the ground.

Disqualification – A penalty applied to a team for a rules violation. A team that is *Disqualified* in a *Qualifying Match* receives zero (0) *WP* and *SP*. When a team is *Disqualified* in an *Elimination Match* the entire *Alliance* is *Disqualified* and they receive a loss for the *Match*. At the head referee's discretion, repeated violations and *Disqualifications* for a single team may lead to its *Disqualification* for the entire tournament. Please see Section 3 – The Tournament for further details and associated definitions.

Drive Team Member – Any of the three (3) people allowed in the *Alliance Station* during a *Match* for each team. Only *Student Drive Team Members* are allowed to touch the controls at any time during the *Match*, and interact with the *Robot* as per <SG4>. Teams are allowed one (1) *Adult* as a *Drive Team Member*, but this *Adult* is not allowed to touch the controls or interact with the *Robot* as per <SG4>.

Driver Controlled Period – The 1:45 (one minute and forty-five second) time period when the *Drivers* operate the *Robots*.

Entanglement – A robot is considered to have *Entangled* an opposing robot if it has grabbed or hooked the opponent robot.

Field Element – The foam field tiles, field perimeter, *Autoloader*, *Posts*, *Skyrise Bases*, and all supporting structures.

VEX Robotics Competition - *Skyrise*

Floor Goal – An Alliance Starting Tile.

High Post – One of the two (2) Posts with a normal capacity of four (4) Cubes. High Posts are approximately 47" tall.

Low Post – One of the four (4) Posts with a normal capacity of one (1) Cube. Low Posts are approximately 23" tall.

Match – A Match consists of an *Autonomous Period* followed by a *Driver Controlled Period* for a total time of 2:00 (two minutes).

Medium Post – One of the four (4) Posts with a normal capacity of three (3) Cubes. Medium Posts are approximately 39" tall.

Owned – A Post is *Owned* by an Alliance if its colored Cube is the vertically highest *Scored Cube* on that Post.

Pinning – A Robot is considered to be *Pinning* an opposing Robot if it is inhibiting the movement of an opponent Robot while the opposing Robot is in contact with the foam playing surface and another *Field Element*.

Post – One of the ten (10) vertical PVC pipes attached to the field perimeter, with a diameter of approximately 3", where teams can *Score Cubes*. Posts can be *Low, Medium, or High*.

Preload – The one (1) Cube each team must place on the field such that it is touching its *Robot*, not touching any grey foam tiles or the *Skyrise Base*, and fully within the field perimeter prior to each *Match*.

Robot – Anything that has passed inspection that a team places on the field prior to the start of a *Match*.

Scored – A Cube is *Scored* if it is not touching a *Robot* of the same color and meets one of the following criteria.

1. A Cube is touching a *Floor Goal* of its own color, and is not *Scored* on a *Skyrise*.
2. Any part of a *Post* is within the volume defined by the outer edges of the *Cube*.
3. Any part of a *Skyrise* is within the volume defined by the outer edges of the *Cube* of the same color as the *Alliance Starting Tile* adjacent to the *Skyrise Base*.

Note: If a Cube is *Scored* in a *Floor Goal* and on a *Skyrise*, it will only count on the *Skyrise*.

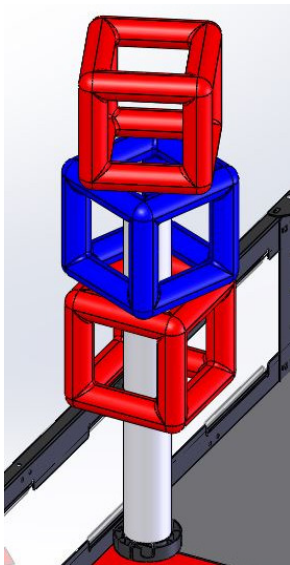

Figure 10 – Bottom two Cubes are Scored, Top Cube is not Scored

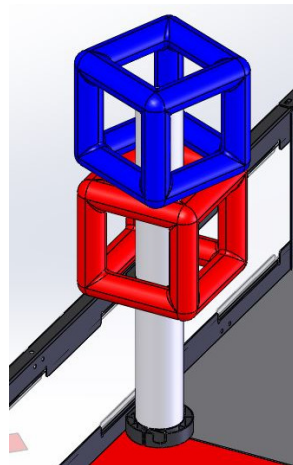

Figure 11 – All Cubes Scored

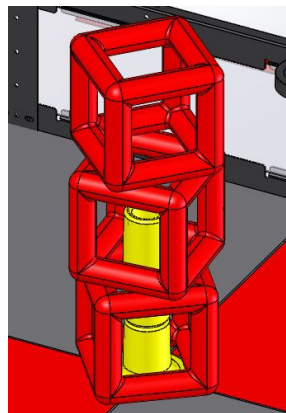

Figure 12 – Bottom two Cubes are Scored, Top Cube is not Scored

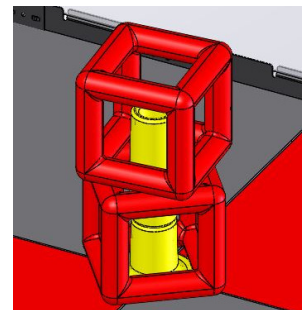

Figure 13 – All Cubes Scored

VEX Robotics Competition - *Skyrise*

Scoring Object – A *Cube* or a *Skyrise Section*

Skyrise – *Skyrise Section(s)* Built on a *Skyrise Base*. *Cubes* can be Scored on a *Skyrise*. *Cubes* may not be scored on a lone *Skyrise Base*.

Skyrise Base – A yellow, plastic cylindrical structure with a height of approximately 4" and a diameter of approximately 3" that is affixed to the *Alliance Starting Tiles*.

Skyrise Section – A yellow, plastic tapered cylindrical structure with a height of approximately 12" and a major diameter of approximately 3".

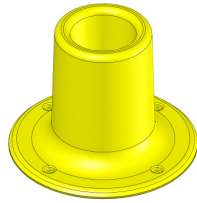

Figure 14 – A *Skyrise Base*



Figure 15 – A *Skyrise Section*

Student – Anyone enrolled in a pre-college school or home-schooled as part of a pre-college educational curriculum and is less than 19 years of age on April 23rd, 2015. Eligibility may be granted based on a disability that has delayed education by at least one year.

Trapping – A *Robot* is considered to be trapped if an opposing *Robot* has restricted it into a small, confined area of the field, approximately the size of one foam field tile or less, and has not provided an avenue for escape.

Game Rules

Scoring

- A *Cube* Scored in a *Floor Goal* is worth one (1) point for the *Alliance* of the color of the *Cube*
- A *Cube* Scored on a *Post* is worth two (2) points for the *Alliance* of the color of the *Cube*
- A *Post* Owned by an *Alliance* is worth one (1) point.
- A *Built Skyrise Section* is worth four (4) points for the *Alliance* of the color of the *Alliance Starting Tile* adjacent to the *Skyrise Base*.
- A *Cube* Scored on a *Skyrise* is worth four (4) points for the *Alliance* of the color of the *Cube*.
- At the end of the *Autonomous Period* the *Alliance* with the most points receives a ten (10) point bonus.

Safety Rules

<S1> If at any time the *Robot* operation or team actions are deemed unsafe or have damaged the *Field Elements* or *Scoring Objects*, including, but not limited to disassembly of *Cubes* and/or *Skyrise Sections*, by the determination of the referees, the offending team may be *Disabled* and/or *Disqualified*. The *Robot* will require re-inspection before it may again take the field.

<S2> If a *Robot* goes completely out-of-bounds (outside the playing field), it will be *Disabled* for the remainder of the *Match*.

Note: The intent is NOT to penalize *Robots* for having mechanisms that inadvertently cross the field border during normal game play.

General Game Rules

<G1> When reading and applying the various rules in this document, please remember that common sense always applies in the VEX Robotics Competition.

<G2> At the beginning of a *Match*, each *Robot* must be smaller than a volume of 18 inches wide by 18 inches long by 18 inches tall. An offending *Robot* will be removed from the match at the Head Referee's discretion.

<G3> Each team shall include up to three *Drive Team Members*. No *Drive Team Member* may fulfill this role for more than one team at any given event.

<G4> Only *Student Drive Team Members* may touch the team's controls at any time during a *Match*, and are the only *Drive Team Members* allowed to interact with the *Robot* as per <SG4>. *Adult Drive Team Members* are not permitted to touch the controls or interact with the robot or *Skyrise Sections*. Minor violations of this rule that do not affect the match will result in a warning. Egregious (match affecting) offenses will result in a *Disqualification*. Teams that receive multiple warnings may also receive a *Disqualification* at the head referee's discretion.

<G5> During a *Match*, the *Drive Team Members* must remain in their *Alliance Station*. *Drive Team Members* may move to their *Alliance Robot Interaction Spots* when interacting with their *Robot* and following rules <G4> and <SG4>.

<G6> During the qualification rounds, the red *Alliance* has the right to place its *Robots* on the field last. During the elimination rounds, the higher seeded *Alliance* has the right to place its *Robots* on the field last. Once a team has placed its *Robot* on the field, its position cannot be readjusted prior to the match. *Robots* must be placed on the field promptly. A Team that violates this rule will have its robots randomly repositioned by the referees.

<G7> *Drive Team Members* are prohibited from making intentional contact with any *Scoring Object*, *Field Element* or *Robot* during a *Match*, with the exception of the contact specified in <SG4> and <SG5> and when protecting themselves from falling *Robots*. Minor violations of this rule that do not affect the match will result in a warning. Egregious (match affecting) offenses will result in a *Disqualification*. Teams that receive multiple warnings may also receive a *Disqualification* at the head referee's discretion.

- a. *Drive Team Members* are not permitted to break the plane of field perimeter at any time during the match, except within the permitted interactions specified in <SG4> and <SG5>.

<G8> During a *Match*, *Robots* may be operated only by the *Student Drive Team Members* and/or by software running in the on-board control system. During the *Autonomous Period* *Drive Team Members* are not permitted to interact with the *Robot* or the controls on their VEXnet Joysticks in any way, directly, or indirectly. (e.g. Triggering sensors without touching the *Robot* is still illegal) Minor violations of this rule that do not affect the match will result in a warning. Egregious (match affecting) offenses will result in a *Disqualification*. Teams that receive multiple warnings may also receive a *Disqualification* at the head referee's discretion.

<G9> It is expected that *Scoring Objects* may unintentionally leave the field during match play. *Scoring Objects* that leave the playing field will be promptly returned to the playing field in approximately the same location from which they exited the field. Teams may not intentionally remove *Scoring Objects* from the field, while not in the process of *Scoring/Building* or removing *Scored/Built Objects*. We do expect *Scoring Objects* to leave the field accidentally during *Scoring/Building*, however doing so intentionally or repeatedly would be a violation of this rule. Minor violations of this rule that do not affect the match will result in a warning. Egregious (match affecting) offenses will result in a *Disqualification*. Teams that receive multiple warnings may also receive a *Disqualification* at the head referee's discretion. Note: *Scoring Objects* will never be returned to the playing field in a *Scored/Built* position.

<G10> Scores will be calculated for all *Matches* immediately after the *Match* after all objects on the field come to rest.

VEX Robotics Competition - *Skyrise*

<G11> *Robots* may not intentionally detach parts during any *Match*, or leave mechanisms on the field. Minor violations of this rule that do not affect the match will result in a warning. Egregious (match affecting) offenses will result in a *Disqualification*. Teams that receive multiple warnings may also receive a *Disqualification* at the head referee's discretion. Multiple intentional infractions may result in *Disqualification* for the entire competition.

<G12> Strategies aimed solely at the destruction, damage, tipping over, or *Entanglement of Robots* are not part of the ethos of the VEX Robotics Competition and are not allowed. However, *VEX Skyrise* is an interactive game. Some incidental tipping, *Entanglement*, and damage may occur as a part of normal game play. If the tipping, *Entanglement*, or damage is ruled to be intentional or egregious, the offending team may be disqualified from that *Match*. Repeated offenses could result in a team being *Disqualified* from the remainder of the competition.

VEX Skyrise is intended to be an offensive game. Teams that partake in solely defensive strategies will undergo extra scrutiny in regard to <G12>. In the case where referees are forced to make a judgment call on interaction between a defensive and offensive *Robot*, the referees will err on the side of the offensive *Robot*.

- a. Robots that have expanded horizontally in an effort to obstruct the field will undergo even more scrutiny under <G12>, and will not be protected under <G12>. e.g. If you choose to undertake this type of strategy, your robot should be built to withstand vigorous interaction.
 - i. Furthermore, teams that undertake this type of obstructive strategy would not be protected by <SG3>. e.g. There is no penalty for pinning a "wall-bot".

A team is responsible for the actions of its *Robot*. This goes for teams that are driving recklessly and potentially causing damage, but also goes for teams that drive around with a small wheel base and arm extended. A team should design its *Robot* such that it is not easily tipped over or damaged by minor contact.

<G13> *Robots* must be designed to permit easy removal of *Scoring Objects* from any grasping mechanism without requiring the *Robot* to have power after a *Match*.

<G14> Field tolerances may vary by as much as ± 1 ", except where otherwise noted, so teams must design *Robots* accordingly. Please make sure to check Appendix A for more specific tolerances.

<G15> Replays are at the discretion of the event partner and head referee, and will only be issued in the most extreme circumstances.

<G16> All teams must adhere to all VEX Robotics Competition Rules as they are written, and must abide by the stated intent of the rules. Every team has the opportunity to ask for official rules interpretations in the VEX Robotics Competition Question & Answer Forum. All responses in this Q&A forum should be treated as official rulings from the VEX Robotics Competition Game Design Committee, and they represent the correct and official interpretation of the VEX Robotics Competition Rules.

There may also be periodic "Team Updates" posted on the *VEX Skyrise* webpage in the competition section of www.vexrobotics.com and www.roboticseducation.org. These updates are also "official" parts of the *VEX Skyrise* rules.

The VEX Robotics Competition Question & Answer Forum can be found at www.vexforum.com, or directly at <http://www.vexrobotics.com/Skyrise>.

<G17> All teams are expected to conduct themselves in a respectful and professional manner while competing in VEX Robotics Competition events. If a team or any of its members are disrespectful or uncivil to event staff, volunteers or fellow competitors, they may be *Disqualified* from a current or upcoming *Match*. It is important to remember that we are all judged based on how we deal with adversity. It is important that we all exhibit maturity and class when dealing with any difficult situations that may present themselves in both the VEX Robotics Competition and our lives in general.

VEX Robotics Competition - *Skyrise*

<G18> All rules in this manual are subject to changes, and not considered official until June 2nd, 2014. We do not expect any major changes to take place, however we do reserve the right to make changes until June 2nd, 2014. There will also be scheduled manual updates on August 1st, 2014 and April 6th, 2015.

VEX *Skyrise* Specific Game Rules

<SG1> At the beginning of each *Match*, each *Robot* must be placed such that it is touching one of its colored *Alliance Starting Tiles*, not touching any *Scoring Object* other than those permitted by <SG2> and not touching any other foam field tiles, the *Skyrise Base*, any *Post*, or the *Autoloader*. No more than one *Robot* may start the match on any one *Alliance Starting Tile*. (See figures 16 & 17)

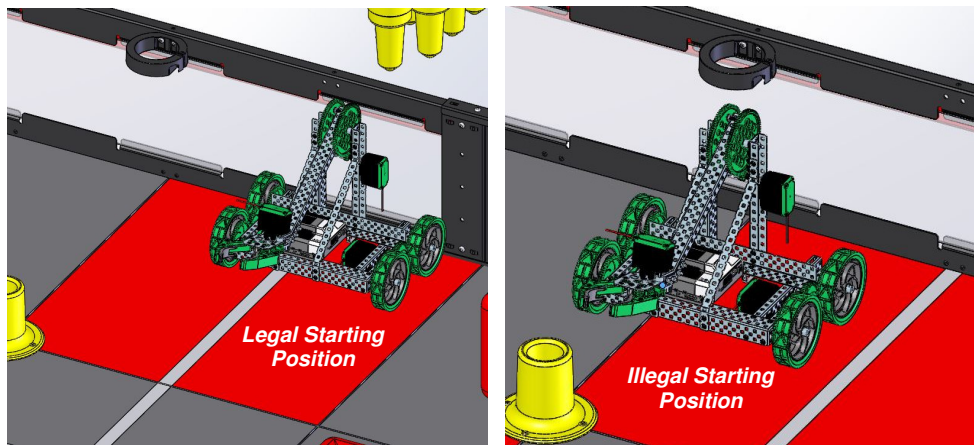

Figures 16 & 17: A legal, and illegal starting position

<SG2> Prior to the start of each *Match*, each *Robot* must use their one (1) *Cube* available as a *Preload*. A *Cube* is considered to be legally preloaded if it is touching the *Robot*, not touching any other grey foam tiles or the *Skyrise Base*, and is fully within the field perimeter. (See figures 18 & 19)

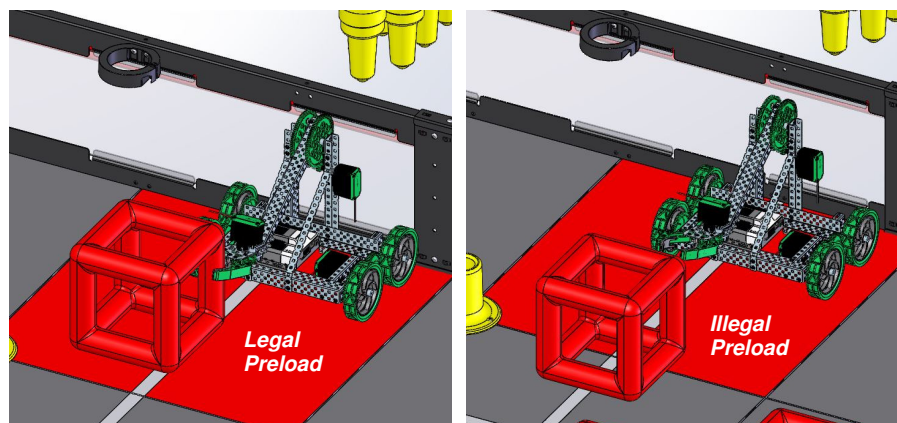

Figures 18 & 19: From left to right, legal Preload, illegal Preload

<SG3> A *Robot* cannot *Pin* or *Trap* an opposing *Robot* for more than five seconds during the *Driver Controlled Period*. A *Pin* or *Trap* is officially over once the *Pinning Robot* has moved away and the *Robots* are separated by at least 2 feet (approximately one (1) foam tile). After ending a *Pin* or *Trap*, a *Robot* may not *Pin* or *Trap* the same *Robot* again for a duration of 5 seconds; if a team does pin the same *Robot* again, the pinning count will resume from where it left off when the pinning *Robot* initially backed off.

Minor violations of this rule that do not affect the match will result in a warning. Egregious (match affecting) offenses will result in a *Disqualification*. Teams that receive multiple warnings may also receive a *Disqualification* at the head referee's discretion. There is no penalty for *Pinning* during the *Autonomous Period*.

VEX Robotics Competition - *Skyrise*

<SG4> During the *Driver Controlled Period*, *Student Drive Team Members* may handle their own *Robot* as long as the robot has **never** left the *Alliance Starting Tile*. The intent of this rule is to allow teams to fix *Robots* that were unable to move at the start of the *Match*. The type of fixes that are allowed is limited to the following:

- a. Turning the Robot on or off
- b. Plugging in a battery
- c. Plugging in a VEXnet Key
- d. Turning the power expander on or off

Minor violations of this rule that do not affect the match will result in a warning. Egregious (match affecting) offenses will result in a *Disqualification*. Teams that receive multiple warnings may also receive a *Disqualification* at the head referee's discretion.

Note: *Student Drive Team Members* may only interact with a *Robot* if they are in the *Alliance Station* or in the general vicinity of the *Alliance Robot Interaction Spot* that corresponds to the *Alliance Starting Tile* the *Robot* is on.

<SG5> There can only ever be one *Skyrise Section* in an *Autoloader* at any one given time. There will be one *Skyrise Section* in the *Autoloader* to start the *Match*. Additional *Skyrise Sections* will be loaded by a *Student Drive Team Member* into the *Autoloader*. *Robots* may not contact a *Skyrise Section* if it is being touched by a human. Minor violations of this rule that do not affect the match will result in a warning. Egregious (match affecting) offenses will result in a *Disqualification*. Teams that receive multiple warnings may also receive a *Disqualification* at the head referee's discretion.

<SG6> Robots are not permitted to remove any *Cubes* that are *Scored* on a *Post* unless the *Cubes* are either:

- a. Partially above the top of the *Post*
- b. Above the defined normal capacity of the *Post*. (e.g. If there are four (4) *Cubes* scored on a *Medium Post*, the bottom three (3) *Cubes* cannot be removed, since the normal capacity of a *Medium Post* is three. However, the fourth and topmost *Cube* may be legally removed.) (See figures 20 & 21)

Minor violations of this rule that do not affect the match will result in a warning. Egregious (match affecting) offenses will result in a *Disqualification*. Teams that receive multiple warnings may also receive a *Disqualification* at the head referee's discretion.

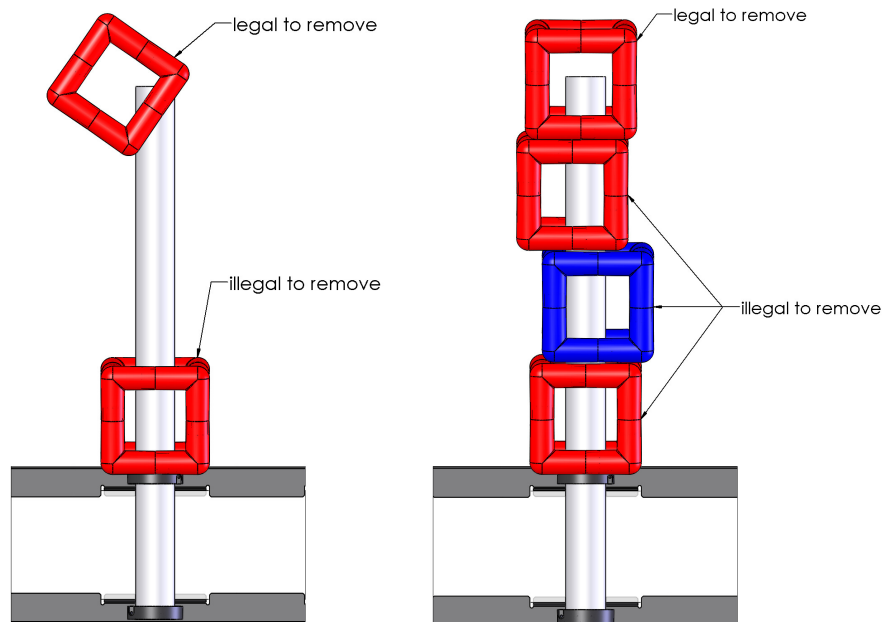

Figures 20 & 21: Examples of Cubes that are legal and illegal to remove

VEX Robotics Competition - *Skyrise*

<SG7> *Scoring Objects* that become split into multiple pieces can no longer be *Scored* or *Built*.

<SG8> Robots may not *Carry* more than one (1) *Skyrise Section* at once. Minor violations of this rule that do not affect the match will result in a warning. Egregious (match affecting) offenses will result in a *Disqualification*. Teams that receive multiple warnings may also receive a *Disqualification* at the head referee's discretion.

<SG9> Robots may not interfere with an opposing Alliance's *Building* of *Skyrise Sections* in any way. The following actions are all illegal.

- Contacting an opponent's *Autoloader* and/or contents. (See Figure 22)
- Contacting an opponent's *Skyrise Base* and/or *Skyrise*. (See Figure 23)
- Contacting an opponent's *Alliance Starting Tile* or the grey foam field tile between the two *Alliance Starting Tiles* and located in the corner of the field. (See Figures 24-25)
- Contacting an opponent's *Robot* that is contacting the foam field tiles mentioned in c) and not contacting any other foam field tiles. (See Figure 26)
- Contacting any *Scoring Objects* that are contacting the foam field tiles mentioned in c) and not contacting any other foam field tiles.
- Depositing *Scoring Objects* in/on the opponent's foam field tiles mentioned in c) or on *Robots* or *Scoring Objects* touching said tiles.

Please note that both direct contact (e.g. Robot making contact) and indirect contact (e.g. Robot contacting a *Scoring Object* that makes contact) are considered violations of the above listed clauses.

Minor violations of this rule that do not affect the match will result in a warning. Egregious (match affecting) offenses will result in a *Disqualification*. Teams that receive multiple warnings may also receive a *Disqualification* at the head referee's discretion. (See Figures 22-26)

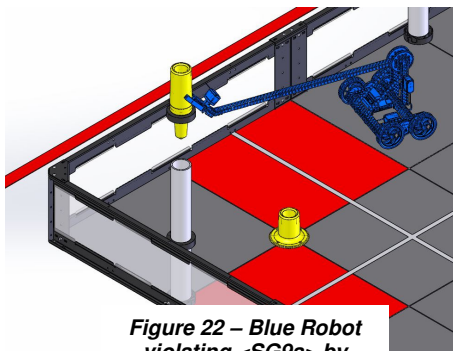

Figure 22 – Blue Robot violating <SG9a> by touching its opponent's *Autoloader*

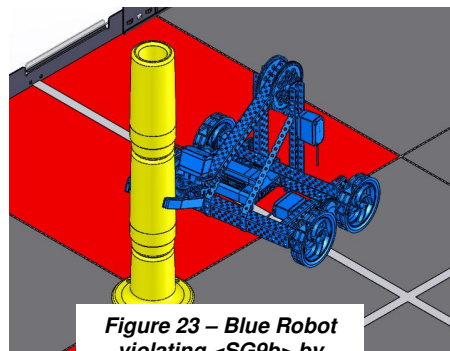

Figure 23 – Blue Robot violating <SG9b> by touching its opponent's *Skyrise*

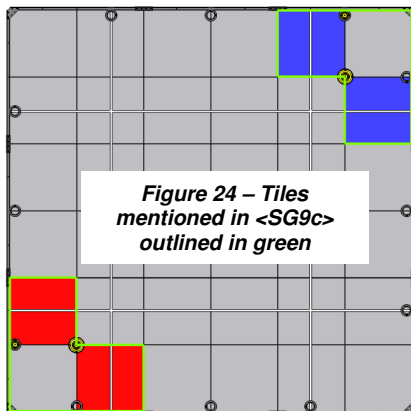

Figure 24 – Tiles mentioned in <SG9c> outlined in green

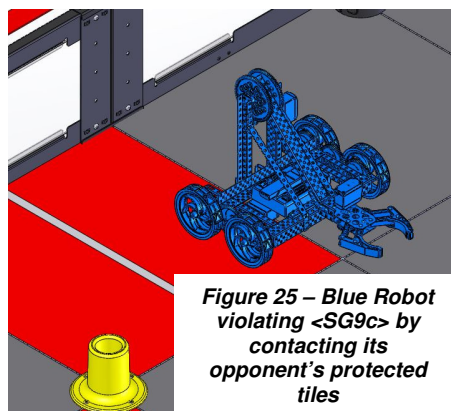

Figure 25 – Blue Robot violating <SG9c> by contacting its opponent's protected tiles

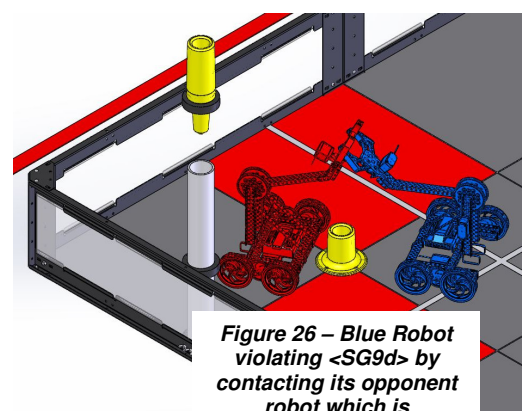

Figure 26 – Blue Robot violating <SG9d> by contacting its opponent robot which is contacting the protected tiles

VEX Robotics Competition - *Skyrise*

<SG10> Intentional strategies causing an opponent to violate a rule are not permitted, and will not result in a foul on the opposing alliance. Minor violations of this rule that do not affect the match will result in a warning. Egregious (match affecting) offenses will result in a *Disqualification*. Teams that receive multiple warnings may also receive a *Disqualification* at the head referee's discretion.

<SG11> Robots may not intentionally grasp, grapple or attach to any *Field Elements*. Strategies with mechanisms that react against multiple sides of a field element in an effort to latch onto said field element are prohibited. The intent of this rule is to prevent teams from both unintentionally damaging the field, and from anchoring themselves to the field. Minor violations of this rule that do not affect the match will result in a warning. Egregious (match affecting) offenses will result in a *Disqualification*. Teams that receive multiple warnings may also receive a *Disqualification* at the head referee's discretion.

<SG12> Any fouls committed during the *Autonomous Period* that do not affect the final outcome of the match, but do affect the outcome of the *Autonomous Bonus*, will result in the *Autonomous Bonus* being automatically awarded to the opposing *Alliance*.

<SG13> Robots may not deposit their opponent's Cubes in/on their own Alliance Starting Tiles or the grey foam field tile between the two Alliance Starting Tiles and located in the corner of the field, or on Robots or Scoring Objects touching said tiles. The intent of this rule is to prevent intentional strategies to permanently isolate the opponent's Cubes in the protected area. Accidental moving of Cubes into this area is expected. Minor violations of this rule that do not affect the match will result in a warning. Egregious (match affecting) offenses will result in a *Disqualification*. Teams that receive multiple warnings may also receive a *Disqualification* at the head referee's discretion.

3

SECTION

The Tournament

Overview

The main challenge of the VEX Robotics Competition will be played in a tournament format. Each tournament will include *Practice*, *Qualifying*, and *Elimination Matches*. After the *Qualifying Matches*, teams will be ranked based on their performance. The top teams will then participate in the *Elimination Matches* to determine the tournament champions.

Tournament Definitions

Alliance Captain – A student chosen to represent their team during *Alliance Selection* for the final *Elimination Matches*.

Alliance Selection – The process of choosing the permanent alliances for the *Elimination Matches*.

Disqualification – A penalty applied to a team for a rules violation. When a team is disqualified in a *Qualifying Match* they receive zero (0) *WP* and *SP*. When a team is disqualified in an *Elimination Match* the entire alliance is disqualified and they receive a loss for the match.

Elimination Match – A match used to determine the championship alliance. Alliances of three (3) face off in a best two (2) of three (3) series, with two teams playing in each match. The first alliance to win two (2) matches will proceed to the next round.

Practice Match – An un-scored match used to provide time for teams to get acquainted to the official playing field.

Qualifying Match – A match used to determine the rankings for the *Alliance Selection*. Alliances compete to earn *Win Points* and *Strength of Schedule Points*.

Strength of Schedule Points (SP) – The second basis of ranking teams. *Strength of Schedule Points* are awarded in the amount of the score of the losing alliance in a *Qualifying Match*.

Win Points (WP) – The first basis of ranking teams. *Win Points* are awarded for winning (two points) and tying (one point) a *Qualifying Match*.

Practice Matches

At the event *Practice Matches* may be played in the morning during the team registration time until the drivers meeting begins. Every effort will be made to equalize practice time for all teams, but they may be conducted on a first-come, first-served basis. These matches are not scored, and will not affect team ranking.

Qualifying Matches

Schedule

- The *Qualifying Match* schedule will be available prior to opening ceremonies on the day of competition. This schedule will indicate alliance partners and match pairings. It will also indicate the alliance's color – red or blue. For tournaments with multiple fields, the schedule will also indicate which field the match will take place on.
- The *Qualifying Matches* will start immediately after opening ceremonies in accordance with the qualifying match schedule.
- Teams will be randomly assigned an alliance partner to compete against two randomly assigned opponents in each *Qualifying Match*.

VEX Robotics Competition - *Skyrise*

- All teams will be scored on the same number of *Qualifying Matches*.
- In some cases, a team will be asked to play in an additional *Qualifying Match*, but will not receive credit for playing this extra match.

Rankings

- At the conclusion of each match, *Win Points (WP)* will be issued:
 - Winning teams of a *Qualifying Match* receive two (2) *WP*
 - Losing teams of a *Qualifying Match* receive zero (0) *WP*
 - If a *Qualifying Match* ends in a tie, all four teams receive one (1) *WP*
 - If a team is *Disqualified* they receive zero (0) *WP*
- All teams in each *Qualifying Match* will also receive *Strength of Schedule Points (SP)*.
 - The number of *SP* assigned for each match, is that of the losing alliance's score.
 - In the event of a tie, both alliances will receive the same *SP* (equal to the tie score).
 - If a team is disqualified they receive zero (0) *SP*
 - If both teams on an alliance are *Disqualified*, the teams on the winning Alliance will be awarded their own score as their *SP* for that match.
- For a *Qualifying Match*, if **no** member of a team is present in the driver station at the start of a match, that team is declared a "no show" and will receive zero (0) *WP* and zero (0) *SP*. A "no show" is treated exactly the same as a *Disqualification*.

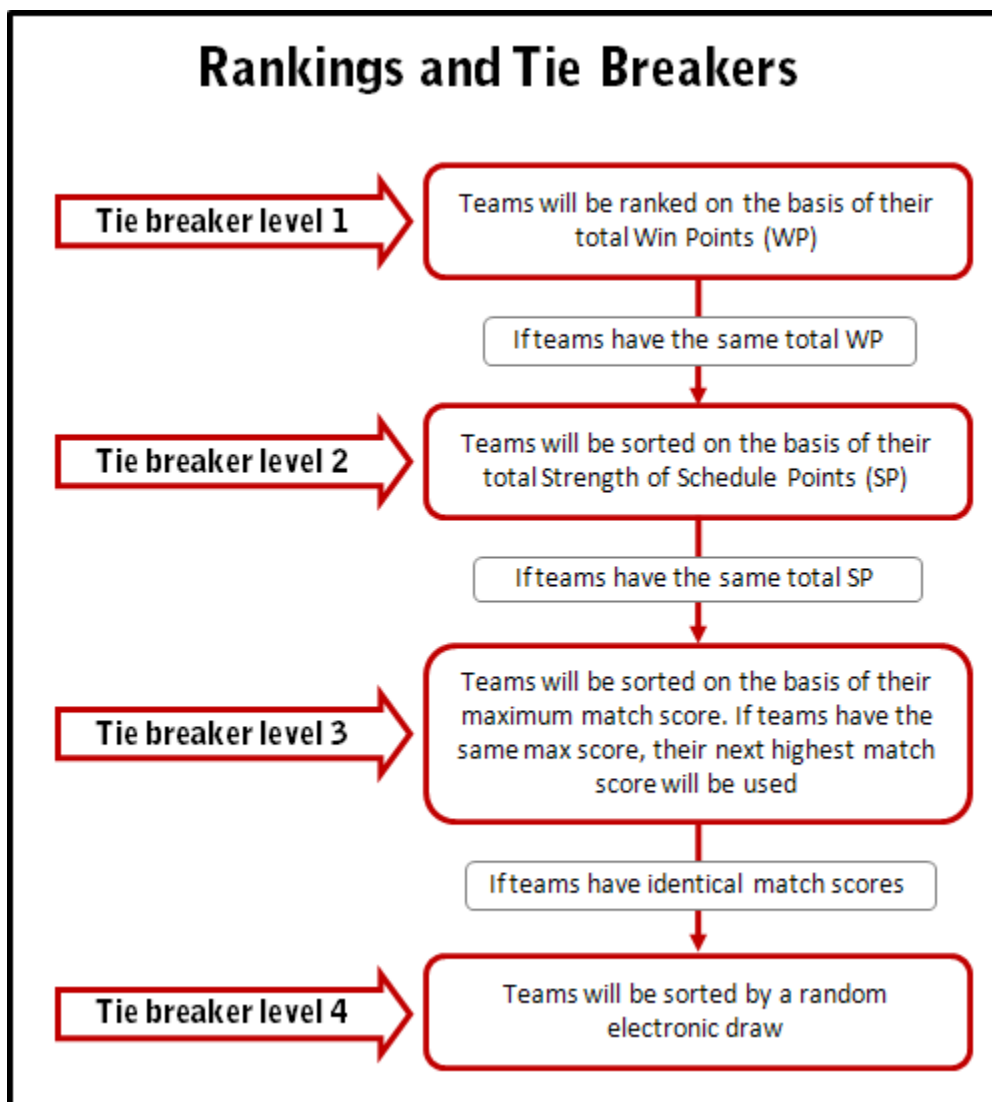

Elimination Matches

- The *Alliance Selection* process will consist of two rounds of selection, such that eight alliance captains will form elimination alliances consisting of three teams.
- These eight alliances will participate in a tournament to determine the event champions.
- If a team is *Disqualified* during an *Elimination Match*, then their entire alliance is *Disqualified*, and the match will be recorded as a loss.

Alliance Selection Process

- Every team will choose a student to act as a team representative.
 - These student representatives will proceed to the playing field at the designated time to represent their teams in the *Alliance Selection*.
- There will be eight alliances formed in the *Alliance Selection*.
- In order of tournament ranking, the student representative of the highest ranked team not already in an alliance will be asked to step forward as an *Alliance Captain* to invite another available team to join their alliance.
- A team is available if they are not already part of an alliance, or have not already declined an alliance invitation.
 - If the team accepts, it is moved into that alliance.
 - If a team declines an invitation, they CANNOT be invited into another alliance, but are still available to select their own alliance if the opportunity arises.
 - If a team declines, the *Alliance Captain* from the inviting team must then extend another invitation.
- This process will continue until all eight *Alliance Captains* have been designated and chosen one alliance partner.
- **The same method is used for each *Alliance Captain's* second choice. Teams will select in the same order they did in the first round.** Any teams remaining after alliance eight makes their second choice will not compete in the *Elimination Matches*.
- Some smaller events may choose to use a different alliance format to better suit the number of teams, please see the event modification section of this document for more details.

Match Ladder

The *Elimination Matches* will play in a ladder format as shown below.

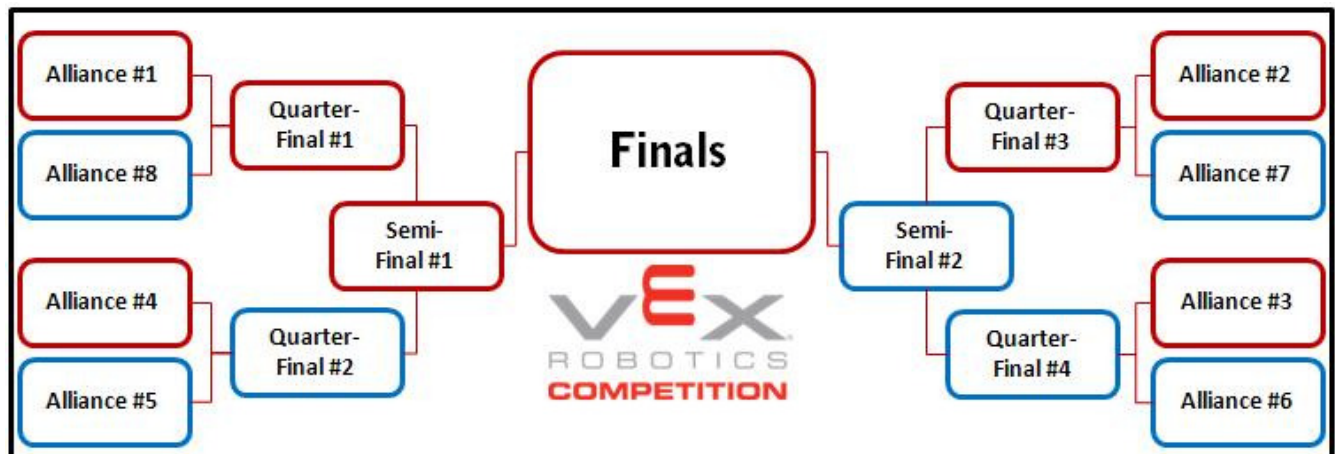

Elimination Scoring

In the elimination rounds, teams do not get *Win Points*; they get a win, loss or tie. Within each bracket of the Elimination Match Ladder, matches will be played to determine which alliance advances, as follows:

- The first alliance to win two matches advances.
- Any tied matches will be replayed until one alliance has two wins, and advances.

Tournament Rules

<T01> Referees have ultimate authority during the competition. **Their rulings are final.**

- a. The referees will not review any recorded replays.
- b. Any questions for the referees must be brought forward by a student drive team member within the time period of two (2) qualifying matches or immediately after the score is announced of an elimination match.

<T02> The only people from a team permitted by the playing field are the three drive team members who are identified by the drive team badges. These badges are interchangeable but not during a match.

<T03> During matches, two teams from an alliance will play on the field. **Any team which sits out the first match in an elimination series, must play in the second match, with no exceptions.** In the third and any subsequent matches, any two of the three teams may play. Prior to each *Elimination Match*, the *Alliance Captain* must let the referee know which two teams will be playing in the upcoming match.

<T04> There are no time outs in the qualifying rounds; in the elimination rounds, each alliance will be allotted ONE time out of no more than three minutes, as permitted by the head referee. The matches must progress according to schedule.

- a. If a robot cannot report for a match, at least one member of the team should report to the field for the match.

<T05> All team members, including coaches, **must** wear safety glasses or glasses with side shields while in the pit or alliance stations during matches. While in the pit area it is highly recommended that all team members wear safety glasses.

Event Modifications

Small Tournaments (Level 1 Tournaments): In the case that an event has fewer than 24 teams (the requisite amount to have eight full alliances), tournaments may be played as follows:

- If there are between 18 and 23 teams at a tournament
 - Alliances will still consist of three teams
 - The number of alliances will be equal to the amount of teams divided by three, less any remainder. (e.g. If there are 19 teams, $19/3 = 6.33 \rightarrow 6$ picking teams)
- If there are 17 or fewer teams
 - Alliances will consist of two teams
 - The number of alliances will be equal to the amount of teams divided by two, less any remainder. (e.g. If there are 13 teams, $13/2 = 6.5 \rightarrow 6$ picking teams)
 - Some tournaments of this size may choose to use unbalanced alliances; having one alliance of 3 teams to allow all teams to participate in the elimination rounds. (e.g. If there are 17 teams, 7 alliances of 2 and 1 alliance of 3). Three team alliances must still adhere to <T03> despite competing against other 2 team alliances.
 - If a tournament is using this format, alliances should be selected as per usual until each alliance has two teams. The remaining team would then be added to the lowest ranked alliance. (e.g. 7th is lower ranked than 6th)
- The match ladder follows the same format as a full tournament, with byes being awarded when there is no applicable alliance. (e.g. If there are seven alliances, there would be no 8th alliance, thereby awarding a bye to the 1st alliance in the quarter-finals.)

Medium Tournaments (Level 2 Tournaments and above): For all tournaments with at least 24 teams, tournaments may be played as follows:

- The standard format of 8 Alliances of 3 teams
- 12 Alliances of 2 teams
 - This setup is recommended for tournaments that do not have enough qualifying spots to qualify an entire three team alliance for the World Championship
 - The elimination bracket for a 12 alliance tournament would play out as follows:

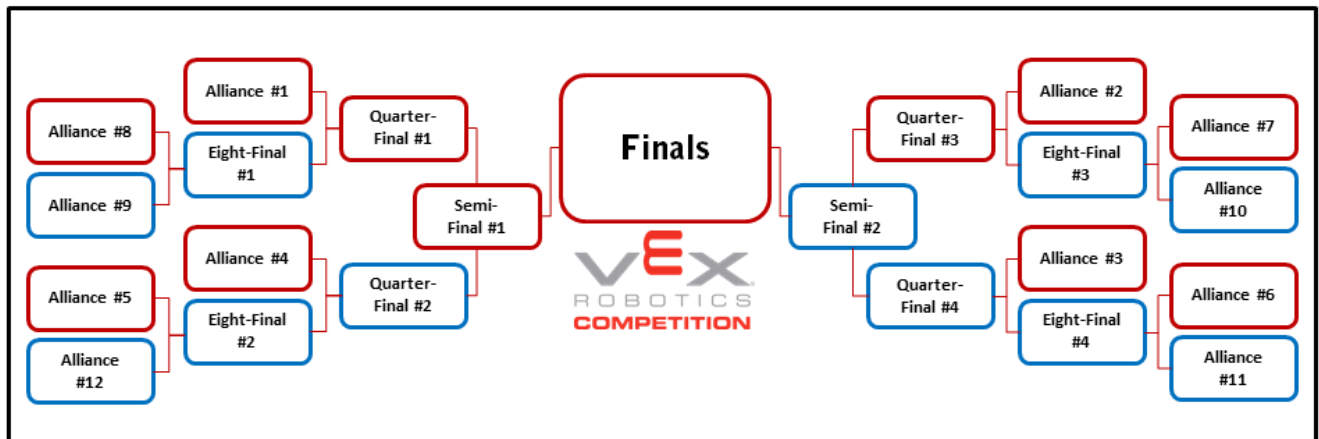

Field Height: At many tournaments the playing field will be placed on the floor. Some tournament organizers may choose to elevate the playing fields by 24" to 36". At the 2015 VEX Robotics World Championship the platforms will be 24" high. For safety reasons, no drive team members will be allowed to stand on any sort of object during a match, despite the presence of raised fields.

4

SECTION

The Robot

Overview

This section provides rules and requirements for the design and construction of your robot. A VEX Robotics Competition robot is a remotely operated and/or autonomous vehicle designed and built by a registered VEX Robotics Competition student team to perform specific tasks when competing in *VEX Skyrise*. Prior to competing at each event, all robots will have to pass an inspection.

Robot Rules

There are specific rules and limitations that apply to the design and construction of your robot. Please ensure that you are familiar with each of these robot rules before proceeding with robot design.

<R1> Only one (1) robot will be allowed to compete per team in the VEX Robotics Competition. Though it is expected that teams will make changes to their robot at the competition, a team is limited to only one (1) robot. The VEX Robotics Design System is intended to be a mobile robotics design platform. As such, a VEX robot, for the purposes of the VRC, has the following subsystems:

Subsystem 1: Mobile robotic base including wheels, tracks, legs, or any other mechanism that allows the robot to navigate the majority of the flat playing field surface. For a stationary robot, the robotic base without wheels would be considered Subsystem 1.

Subsystem 2: Power and control system that includes a VEX legal battery, a VEX control system, and associated motors for the mobile robotic base.

Subsystem 3: Additional mechanisms (and associated motors) that allow manipulation of game objects or navigation of field obstacles.

Given the above definitions, a minimum robot for use in any VRC event (including skills challenges) must consist of 1 and 2 above. Thus if you are swapping out an entire subsystem of either item 1 or 2, you have now created a second robot and are no longer legal.

- a. Teams may not compete with one robot, while a second is being modified or assembled.
- b. Teams may not switch back and forth between multiple robots during a competition.

<R2> Every robot will be required to pass a full inspection before being cleared to compete. This inspection will ensure that all robot rules and regulations are met. Initial inspections will take place during team registration/practice time.

- a. If significant changes are made to a robot, it must be re-inspected before it will be allowed to compete.
- b. All robot configurations must be inspected before being used in competition.
- c. Teams may be requested to submit to random spot-inspections by event personnel. Refusal to submit will result in disqualification.
- d. Referees or inspectors may decide that a robot is in violation of the rules. In this event, the team in violation will be disqualified and the robot will be barred from the playing field until it passes re-inspection.

<R3> The following types of mechanisms and components are NOT allowed:

- a. Those that could potentially damage playing field components.
- b. Those that could potentially damage other competing robots.
- c. Those that pose an unnecessary risk of entanglement.

VEX Robotics Competition - *Skyrise*

<R4> At the beginning of any match, robots must be smaller than 18" x 18" x 18".

- a. During inspections, robots will be measured in one of two ways
 - i. Robots will be placed into a "sizing box" which has interior dimensions matching the above size constraints. To pass inspection, a robot must fit within the box without touching the box walls or ceiling.
 - ii. Robots will be sized using a VRC Robot Sizing Tool. Robots will be placed on a flat surface and must not touch the measurement slide as it is passed over the surface. Please see <http://www.vexrobotics.com/vex/products/competition-products/vrc-products/276-2086.html> for a visual reference
- b. Robots may expand beyond their starting size constraints after the start of a match.
- c. Any restraints used to maintain starting size (i.e. zip ties, rubber bands, etc) MUST remain attached to the robot for the duration of the match.

<R5> Robots may be built ONLY from Official **Robot** Components from the VEX Robotics Design System unless otherwise specifically noted within these rules.

- a. During inspections if there is a question about whether something is an official VEX component, a team will be required to provide documentation to an inspector, which proves the component's source. Such types of documentation include receipts, part numbers, or other printed documentation.
- b. Only the VEX Robotics Design System Components specifically designed to be used for Robot construction are allowed. Using additional components outside their typical purpose is against the intent of the rule (i.e. please don't try using VEX apparel, competition support materials, packaging or other non-robot products on a VEX Robotics Competition Robot).
- c. Products from the VEXpro, VEX IQ, or VEX Robotics by Hexbug product line cannot be used for robot construction, unless specifically allowed by a clause of <R7>. Products from the VEXpro or VEX IQ, or VEX Robotics by Hexbug product line which are also cross listed as part of the VEX product line are legal.
- d. Official Robotics Components from the VEX Robotics Design System which have been discontinued are still legal for competition use. However teams must be cognizant of <R5a>

<R6> Official VEX products are ONLY available from VEX & Official VEX Resellers. To determine whether a product is "official" or not, consult www.vexrobotics.com.

<R7> Robots are allowed the following additional "non-VEX" components:

- a. Any material strictly used as a color filter or a color marker for a VEX Light Sensor.
- b. Any parts which are **identical** to legal VEX parts. For the purposes of this rule, products which are identical in all ways except for color are permissible. Note: It is up to inspectors to determine whether a component is "identical" to an official VEX component.
- c. Any commercially available #4, #6, #8, M2, M2.5, M3 or M4 screw up to 2" long, and any commercially available nut to fit these screws.
- d. Teams may add non-functional decorations provided that these do not affect the robot performance in any significant way or affect the outcome of the match. These decorations must be in the spirit of the competition. Inspectors will have final say in what is considered "nonfunctional".
 - i. Anodizing and painting of parts would be considered a legal nonfunctional decoration
 - ii. Any guards or decals must be backed by legal materials that provide the same functionality.
 - i.e. If your robot has a giant decal that prevents *Scoring Objects* from falling out of the robot, the decal must be backed by VEX material that also prevents the *Scoring Objects* from falling out.
 - iii. If using the VEX speaker (Part #276-1504), the chosen audio must not be distracting and must be in good taste. The Head Inspector and Head Referee will make the final decision on the appropriateness of the audio
- e. Any non-aerosol based grease or lubricating compound, when used in **extreme** moderation on surfaces and locations that do NOT come into contact with the playing field walls, foam field surface, game objects, or other robots.

VEX Robotics Competition - *Skyrise*

- f. Non shattering plastic from the following list; polycarbonate, acetel monopolymer (Delrin), acetel copolymer (Acetron GP), POM (acetel), ABS, PEEK, PET, HDPE, LDPE, Nylon (all grades), Polypropylene, FEP; as cut from a single 12" x 24" sheet up to 0.070" thick.
 - i. Plastic can be mechanically altered by cutting, drilling or bending etc., but **it cannot be chemically treated, melted or cast.** Teams may heat the polycarbonate to aid in bending.
- g. A small amount of tape may be used for the following purposes:
 - i. For the sole purpose of securing any connection between the ends of two (2) VEX cables.
 - ii. For labeling wires and motors.
 - iii. Teflon tape solely for the purposes of preventing leaks may be used on the threaded portions of pneumatic fittings.
 - iv. For securing and retaining a VEXnet key to the VEX ARM® Cortex®-based Microcontroller. Using tape in this manner is highly recommended to ensure a robust connection.
- h. Hot glue for securing cable connections
- j. A USB extension cable may be used for the sole purpose of remote mounting of a VEXnet key. The key must be mounted in the following manner.
 - i. The VEXnet key must be mounted such that no metal is touching the key above the VEXnet logo.
 - ii. We highly recommend that no metal may be within 2" of the top of the VEXnet key.
- k. An unlimited amount of 1/8", braided, nylon rope
- l. Items used solely for the purpose of bundling or wrapping of 2-wire, 3-wire, 4-wire cables, and pneumatic tubing, for the purposes of protection, organization, or management are allowed. This includes but is not limited to electrical tape, cable carrier, cable track, etc. Note: it is up to inspectors to determine whether a component is serving a function beyond protecting and managing cables.
- m. VEX IQ pins used solely for the purpose of attaching VEX Team Identification Number Plates.

<R8> Additional VEX Robotics Design System Components that are released during the competition season are considered legal for use.

- a. Some "new" components may have certain restrictions placed on them upon their release. These restrictions will be documented in a Team Update. Team Updates will be posted to the VEX *Skyrise* home page in the Competition section of www.VEXrobotics.com

<R9> Robots must use ONLY one (1) VEX EDR Microcontroller.

- a. Examples of VEX EDR Microcontrollers are the VEX v.5 PIC Microcontroller and the VEX ARM® Cortex®-based Microcontroller.
- b. Microcontrollers that are part of other VEX product lines such as VEXpro, VEX RCR, VEX IQ, or HEXBUG VEX Robotics are not allowed.

<R10> Robots must ONLY utilize the VEXnet system for all robot communication.

- a. VEX 75Mhz Crystal Radios are prohibited. (Some events may allow the use of 75Mhz Crystal Radios, please see the Special Event Rule Modifications later in this section.)
- b. Electronics from the VEXpro, VEX-RCR, VEX IQ, or HEXBUG VEX Robotics product line are prohibited including all VEXplorer electronics.
- c. A VEXnet Joystick may only be used in conjunction with a VEX ARM® Cortex®-based Microcontroller. A VEXnet upgraded 75MHz Transmitter may only be used in conjunction with a PIC Microcontroller. Mixing and matching VEXnet transmitters and receivers is prohibited.

<R11> Robots may use up to ten (10) VEX EDR motors or VEX Servos (Any combination, up to ten)

- a. 2-Wire Motors must be controlled by a 2-Wire Motor Port, either directly on a VEX Microcontroller (P/N 276-2194), or on a "VEX Motor Controller 29" module.
- b. Teams may NOT use multiple 2-wire Motor Ports, 3-wire PWM Motor Ports, or Motor Controller 29 modules on a single motor.

<R12> A maximum of one (1) VEX Y-cable can be used per Motor Port of the Microcontroller or Power Expander. (You cannot "Y off a Y" to have more than two (2) motors controlled by the same Motor Port.)

- a. Teams using the VEX ARM® Cortex®-based Microcontroller can only power one (1) 2-wire Motor per each of the two 2-wire motor ports on the Microcontroller. It is illegal to "Y" off a 2-wire Motor Port.
- b. Teams may not "Y" off a Motor Controller 29

VEX Robotics Competition - *Skyrise*

<R13> The only allowable sources of electrical power for a VEX Robotics Competition Robot is any single (1) VEX 7.2V Robot Battery Pack of any type, unless the robot is utilizing the VEX Power Expander, and a single (1) 9V backup battery. Robots utilizing the VEX Power Expander can use a second (2) VEX 7.2V Robot Battery of any type.

- a. Additional batteries cannot be used on the robot (even ones that aren't connected).
- b. Robots are permitted to use a maximum of one (1) VEX Power Expander
- c. To ensure reliable wireless communication, it is required that all teams connect a charged 9V Backup battery to their VEXnet system using the VEXnet Backup Battery Holder (276-2243).
- d. Any VEX 7.2V Battery Pack is legal, in the quantities described above.
- e. The only legal means for charging a VEX 7.2V Battery Pack is via one of the following VEX Battery Chargers: Smart Charger, 276-1445; Smart Charger v2, 276-2519; 276-2221 (discontinued), 276-2235 (discontinued). All other chargers are strictly prohibited.
- f. VEXnet Joysticks must only be powered by AAA batteries

<R14> No more than two VEX hand-held transmitters may control a single robot during the tournament. No modification of these transmitters is allowed of ANY kind.

- a. No other methods of controlling the robot (light, sound, etc) are permissible.

<R15> Parts may NOT be modified as follows:

- a. Motors (including the internal PTC), extension cords, sensors, controllers, battery packs, reservoirs, solenoids, pistons and any other electrical component or pneumatics component of the VEX Robotics Design System may NOT be altered from their original state in ANY way.
 - Internal or external mechanical repairs of VEX Limit and Bumper switches are permitted
 - Using components from these devices in other applications is prohibited
 - External wires on VEX electrical components may be repaired by soldering, using twist/crimp connectors, electrical tape or shrink tubing such that the original functionality / length is not modified in any way. Wire used in repairs must be identical to VEX wire.
Teams may make these repairs at their own risk; incorrect wiring may have undesired results.
 - Teams may change or replace the gears in the "2-Wire 393" or "2-Wire 269" motors, with the corresponding official VEX Replacement Gears
 - Teams may cut pneumatic tubing to a desired length
- b. Welding, soldering, brazing, gluing, or attaching in any way that is not provided within the VEX Robotics Design System will NOT be allowed.
 - Mechanical fasteners may be secured using Loctite or a similar thread-locking product.
 - This may be used for securing hardware ONLY.
 - Teams are permitted to fuse/melt the end of the 1/8" nylon rope to prevent fraying
 - The gluing permitted by <R7h> is an exception to this rule.

<R16> The Robot on/off switch must be accessible without moving or lifting the robot. The Robot Microcontroller lights should also be visible by competition personnel to assist in diagnosing robot problems.

<R17> Teams must bring their robots to the field prepared to play. Teams who use VEX pneumatics must have their systems charged before they place the robot on the field.

<R18> Pneumatic devices may only be charged to a maximum of 100 psi. Teams may only use a maximum of two (2) legal VEX pneumatic air reservoirs on a Robot.

- The intent of this rule is to limit teams to the air pressure stored in two reservoir tanks, as well as the normal working air pressure contained in their pneumatic cylinders and tubing on the robot. Teams may not use other elements (e.g. surgical tubing) for the purposes of storing air pressure. Teams who use cylinders and additional pneumatic tubing for no purpose other than additional storage are in violation of the spirit of this rule and will fail inspection.

VEX Robotics Competition - *Skyrise*

<R19> To participate in an official VEX Robotics Competition Tournament a team must first register on robotevents.com. Upon registering they will receive their VEX Team Identification Number (VEX Team ID#) and a welcome kit containing VEX Team Identification Number Plates. Every robot should have their VEX Team ID# Plates displayed on a minimum of 2-opposing sides.

- a. The VEX Team Identification Number Plates are considered a non-functional decoration, and cannot be used as a functional part of the robot.
- b. These number plates must fulfill all robot rules (i.e. they must fit within the 18" cube per <R4>, they cannot cause entanglement, etc.)
- c. Robots must use the colored plates that match their alliance color for each match. (i.e. Robots on the red alliance must have their red plates on for the match)



<R20> Some events will require VEX Robot Identification Flags. At these events, robots must include a mounting device to securely hold one VEX Robot Identification Flag throughout an entire match.

- a. The VEX Robot Identification Flags are considered a non-functional decoration, and cannot be used as a functional part of the robot.
- b. These flags must fulfill all robot rules (i.e. they must fit within the 18" cube per <R4>, they cannot cause entanglement, etc.)

Notes on VEX Robot Identification Flags:

- The flags will be issued to teams in their VEX Robotics Competition registration materials.
- These flags may also be available at some events
- Replacement and extra flags are available for purchase at www.vexrobotics.com
- For flag details please refer to the following diagram.
- VEX Threaded Standoffs work as simple flag holders, as shown below.
- Please contact your local event partner to see if they are required at your event.

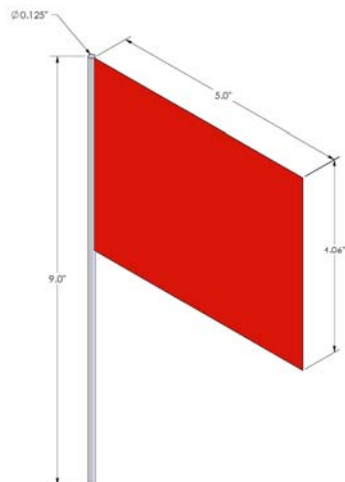

VEX Robotics Competition - *Skyrise*

<R21> During the Autonomous Period human operators will not be allowed to use their hand-held controllers. As such, teams are responsible for programming their robot with custom software if they want to perform in Autonomous mode.

For more information on this, teams should consult the help guides produced by the developers of their chosen programming software.

<R22> Any violation of robot rules will result in a team being unable to play until they pass inspection (per <R2d>). In addition, teams who intentionally circumvent or violate rules to gain an advantage over their fellow competitors are in violation of the spirit and ethos of the competition. As such, anyone caught violating a rule in this manner may be disqualified from upcoming matches, the event, or even future events at the discretion of the VEX Robotics Competition Game Design Committee.

Special Event Rule Modifications

The rules listed in this section represent the way the game will be played at ALL VEX Robotics Competition “Championship” Events. We know that some events will choose to modify the rules slightly to suit unique circumstances. In particular, we expect some events will make the following rule exceptions:

- a. Utilize the VEX 75 Mhz Crystal Radio Transmitter & Receiver instead of or in conjunction with the VEXnet Wireless link.
- b. Allow AA batteries to power the robot instead of a VEX 7.2V Battery Pack
- c. Require the use of VEX Robot Identification Flags. (See <R20>)

If an event makes the changes they need to inform all attending teams. It is especially important that any 75 Mhz events make sure their teams are using the correct communication type.